

PATENT SPECIFICATION



Application Date: Dec. 14, 1931. No. 34,657/31.

394,325

Complete Left: Nov. 10, 1932.

Complete Accepted: June 14, 1933.

PROVISIONAL SPECIFICATION.

**POOR
QUALITY**

Improvements in and relating to Sound-transmission, Sound-recording and Sound-reproducing Systems.

We, ALAN DOWER BLUMLEIN, of 57, Earl's Court Square, London, S.W. 5, a British subject, and ELECTRIC AND MUSICAL INDUSTRIES, LIMITED, of Blyth Road, Hayes, in the County of Middlesex, a company registered under the laws of Great Britain, do hereby declare the nature of this invention to be as follows:—

10. This invention relates to the transmission, recording and reproduction of sound and is more particularly directed to systems for recording and reproducing speech, music and other sound effects, especially when associated with picture effects as in talking motion pictures.

15. The fundamental object of the invention is to provide a sound recording and reproducing system whereby a true directional impression may be conveyed to a listener thus improving the illusion that the sound is coming, and is only coming, from the artist or other sound source presented to the eye. In order that the physical basis of the invention can be appreciated and the stages of its development understood, known and established facts concerning the physical relations between sound sources, sound waves emitted thereby, and the human ears will be briefly summarised.

20. Human ability to determine the direction from which sound arrives is due to binaural hearing, the brain being able to detect differences between sounds received by the two ears from the same source and thus to determine angular direction. This function is well known and has been employed to considerable extent for example in sub-aqueous directional detection in which two microphones are connected by headphones, one to each ear of an observer, the two channels between the microphones and the two ears being kept entirely separate.

25. With two microphones correctly spaced and the two channels entirely separate it is known that this directional effect can also be obtained for example in a studio, but if the channels are not kept separate (for example, by replacing the headphones by two loud speakers) the effect is largely lost. The invention contemplates con-

trolling the sound, emitted for example by such loud speakers, in such a way that the directional effect will be retained.

30. The operation of the ears in determining the direction of a sound source is not yet fully known but it is fairly well established that the main factors having effect are phase differences and intensity differences between the sounds reaching the two ears, the influence which each of these has depending upon the frequency of the sounds emitted. For low frequency sound waves there is little or no difference in intensity at the two ears but there is a marked phase difference. For a given obliquity of sound the phase difference is approximately proportional to frequency, representing a fixed time delay between sound arriving at the two ears, by noting which the brain decides the direction from which the sound arrives. This operation holds for all frequencies up to that at which there is a phase difference of π radians or more between sounds arriving at the two ears from a source located on the line joining them; but above such a frequency if phase difference were the sole feature relied upon for directional location there would be ambiguity in the apparent position of the source. At that stage however the head begins to become effective as a baffle and causes noticeable intensity differences between the sounds reaching the two ears, and it is by noting such intensity differences that the brain determines direction of sounds at higher frequencies. It has been stated that the frequency at which the brain changes over from phase- to intensity-discrimination occurs at about 700 c.p.s. but it must be understood that this may vary within quite wide limits in different circumstances and from person to person, and that in any case the transference is not sudden or discontinuous but there is considerable overlap of the two phenomena so that over a considerable frequency range differences of both phase and intensity will to some extent have an effect in determining the sense of direction experienced.

35. From the above considerations it will be clear that a directional effect is to be

obtained by providing low-frequency phase differences and high-frequency intensity differences at the two ears, and it would appear that in reproducing from two loud speakers the differences received by two microphones suitably spaced to represent human ears would give this effect to a listener if each microphone were connected only to one loud speaker. It can be shown however that phase differences necessary at the ears for low-frequency directional sensation are not produced by phase differences at two loud speakers (both of which communicate with both ears) but are produced by intensity differences at the speakers: while initial intensity differences from the sources necessary for high-frequencies are not sufficiently marked when the sounds reach the ears, and to produce suitable effects therefore the initial differences must be amplified.

It will be seen therefore that the invention consists broadly in so controlling the intensities of sound to be or being, emitted by a plurality of loud speakers or similar sound sources, in suitable spaced relationship to the listener, that the listener's ears will note low-frequency phase differences and high-frequency intensity differences suitable for conveying to the brain a desired sense of direction of the sound origin.

It must be understood that the controlling of intensities of a plurality of loud speakers spaced, for example, round a motion picture screen has previously been proposed and no novelty for mere intensity control per se is claimed, except insofar as the nature of the control is such as to provide the necessary phase and intensity difference sensations. If the sound is first recorded and subsequently reproduced from the records, the control may be wholly effected either during the recording or during reproduction, or may be partially carried out in each stage.

More specifically the invention consists in a method of transmitting, recording and/or reproducing sound wherein a plurality of transmission channels so interact, each upon each, or are in such relation or so relatively modified in combination and subsequently re-separated, that the complete intelligence initially transmitted is further conveyed, differently arranged, between the channels.

The invention also consists in a method of transmitting, recording and/or reproducing sound wherein phase differences between a plurality of signals are converted into amplitude differences.

The invention also consists in apparatus and means for carrying into effect the above specified methods of sound trans-

mission, recording and/or reproduction, and in further features which will become apparent from the following description of one manner of carrying out the invention. It must be understood however that this description is given merely by way of example and does not impose any restrictions upon the scope of the invention or the manner and means whereby it may be accomplished.

It will be clear that the invention is particularly applicable to talking motion pictures and the following description will therefore be given with reference to this application. In one form of the invention convenient for this purpose the sounds to be recorded and reproduced with the pictures may be received by two pressure microphones mounted on opposite sides of a block of wood to represent ears on an artificial head. The outputs from the two microphones are taken to suitably arranged transformers or bridge or network circuits which convert the two primary channels into two secondary channels which may be called the summation and difference channels. These are arranged so that the current flowing into the summation channel will represent half the sum, or the mean, of the currents flowing in the two original channels, while the current flowing into the difference channel will represent half the difference of the currents in the original channels. If the original currents differ in phase only, the current in the difference channel will be $\frac{\pi}{2}$ different in phase from the current in the summation channel. This difference current is then passed through a condenser; the voltage across this condenser will be in phase with the summation channel current. By passing the summation channel current through a resistance, a voltage is obtained which remains in phase with the voltage across the condenser in the difference channel. These two voltages are then combined and re-separated by the same process as previously adopted so as to produce two final channels. The voltage in the first final channel will be the sum of these voltages and the voltage in the second final channel will be the difference between these voltages. Since these voltages were in phase the two final channels will be in phase but will differ in magnitude. By choosing the value of the shunt resistance in the summation channel and the shunt condenser in the difference channel for a given frequency, any degree of amplitude difference in the final channel can be obtained for a given phase difference in the original channels. For the low fre-

quencies it can be shown that the phase difference between the waves will, for a given obliquity of the sound source, vary proportionately with frequency, being very small for a very low frequency. Hence the use of a shunt condenser in the difference circuit will have the effect of producing a fixed intensity difference in the final channels for a given obliquity at all low frequencies.

For the higher frequencies as indicated above it is not necessary to convert phase shifts into amplitude differences, but simply to modify amplitude differences. The shunt condenser in the difference circuit is therefore built out with a resistance whose value determines the degree of modification.

It may be found necessary to employ more complex circuits than the shunt resistance and condenser in the summation circuit and shunt resistance in the difference circuit, which however form the basic arrangement. However it must be understood that the circuits employed may be considerably modified as required without departing from the scope of the invention.

If two very small microphones are used and placed very close together it may be found possible to obtain microphone outputs which do not differ appreciably in amplitude but only in phase for all working frequencies. In this case the modifying circuit would be arranged to convert phase differences into amplitude differences throughout the entire frequency range. The phase differences dealt with at the low-frequencies however may be so small that in this case slight differences in the two microphone circuits would have very large effects. On this account microphone spacing of the same order as that of the human ears is most suitable.

The impulses transmitted through the two channels as indicated above may then be recorded on two sound tracks on a film, for example, by any suitable or known means, which record may comprise a sound track of constant density and variable width (e.g. an oscillograph record), or a sound track of constant width and variable density (e.g. a Kerr cell record).

Such a record may be reproduced by passing light from the same slit through the two tracks, separating the beam into the two record portions by means of prisms or like optical means and employing the outputs from two photo-electric cells, excited by these separate parts of the beam (after amplification) to operate two loud speakers disposed one on each side of the screen upon which the cinematograph pictures are projected.

It will be appreciated that the amount of modification of the impulses transmitted through the summation and difference channels as indicated above depends upon a number of factors, including the relative spacing of the microphones and of the loud speakers, and the size and positioning of the screen. It can be shown that for low frequencies ω the degree of modification required in the difference channel as compared with the modification in the summation channel is given by:—

$$K = \frac{2v}{j\omega} \cdot \frac{y}{\theta k} \cdot \frac{s}{x}$$

where

v = velocity of sound.

y = fraction of half picture film width which the image of the sound source is off centre.

θ = angle of obliquity, in radians, of the source from the median plane between the microphones.

k = effective distance apart of the microphones.

s = width of screen of theatre.

x = distance apart of loud speakers in theatre.

This expression in effect gives the impedance of the shunt capacity in the difference channel in terms of the resistance in the summation channel. It holds for all frequencies where k is small compared to the wavelength, and is based on the assumption that the θ is small and that x and s are small compared with the distance of the listener from the screen and loud speakers.

The portion $\frac{y}{\theta k}$ is a factor of the recording, and is constant for a given arrangement if either the camera is in line with the microphones and the centre of the picture, or the action does not move appreciably to or from the microphones and camera. When recording, the relative distances of camera and microphones and the focal length of the lens may be adjusted to maintain this factor a constant.

The expression $\frac{s}{x}$ is a constant for the theatre. As regards low frequencies only, the distance apart of the speakers need not exceed the screen width, but should certainly not be closer than 70% of the screen width. The closer the loud speakers the greater the necessary power handling capacity, but the less the troubles introduced by formation of stationary waves.

For the high frequencies no definite expression can easily be obtained, and the modification used will probably have to

be gauged empirically by trial and error.

The arguments and formula given above are based on a direct wave analysis and may have to be considerably modified in order to allow for reflection or other acoustic effects. It is preferred therefore to introduce the modifications it is proposed to employ, at the theatre since all factors will then enter into consideration. It will be clear that, as indicated above, the modifying networks and channel arrangements may be employed between the microphones and the film during recording, or between the record and the loud speakers during reproduction, and the latter course, in addition to allowing of adjustment of the arrangements to suit the particular theatre as indicated above, has the additional advantage that the sound film can be reproduced by a single reproducing head or channel if for example one of the dual arrangements breaks down, or in a theatre which, having one installation, does not wish to go to the expense of installing a second apparatus.

In order to employ successfully a system of the kind described above it is necessary to carry out preliminary experiments to determine the most suitable value of modification to be employed for each recording, and it is also necessary to standardise various factors entering into every recording. In the preliminary experiments, before recording, volume indicator measurements may be made with a standard source placed at the extremes of the "set", i.e. the space within which recording is to be effected, and from these the proposed modifying network laid out. A further experiment may also be effected to standardise phase angles on the film. At the theatre a simple adjustment may be provided to check and balance the input to the two channels, a length of test film being used for this purpose. It will thus be seen that the total theatre equipment necessary is very simple and consists in a transmission modifier (comprising two or four transformers, for example, artificial line resistances and the control network, which may be no more than a condenser and a resistance) and two normal sound-reproducing heads or pick-ups, or one specially designed head or pick-up adapted to separate the two recordings to two complete reproducing channels. There is no reason why the second channel used should not be the "stand-by" channel now often installed for safety since if, as indicated above, one of the channels breaks down reproduction may be continued without serious consequences on the other channel only.

In connection with the standardisation

indicated above, while the binaural "transfer" frequency (from phase- to intensity-discrimination) need have no definite significance in recording, since it is a function of the human brain it is nevertheless necessary to fix a change-over frequency from high- to low-frequency working for recording, since this frequency fixes the form of modification to be used, the distance apart of the microphones and the form of baffle between them. Any convenient frequency may be chosen as standard after experience has decided which is most suitable. Instead of standardising it may be possible from the preliminary experiments to allow electrically for variation of microphone positions and/or of microphone spacing (although the latter would be extremely difficult) and it must be understood that this arrangement falls within the scope of the invention.

The above described system is based upon considerations in which no account is taken of sound reflections or interference either during recording or reproduction. If difficulties arise from this cause they may be overcome by employing a second pair of loud speakers differently spaced and having a different modifying network from the first pair: or a row of speakers may be used with a composite, progressive modifying network to supply them: or the two speakers may be placed comparatively close together, no directional effect in this case being given to high frequencies, except insofar as a phase difference (when the angle of obliquity of the sound varies only within such very small limits as to avoid ambiguous results) may be employed to give some such effect even at high frequencies.

The system so far described employs to receive the sound waves two pressure microphones. Velocity or moving conductor microphones (e.g. moving strip microphones) are also very suitable and may be employed, in which case various alterations in the system may be necessary. Such velocity microphones give a response varying as the cosine of the angle of incidence of the sound relative to the direction of normal or optimum incidence, and they have the advantage in the present system that a specific degree of loud speaker output separation may be obtained without phase-conversion or like network modifications.

Three general arrangements employing velocity microphones are possible, and in all cases the microphones are placed as near together as possible instead of being spaced as artificial ears, as in the case of pressure microphones.

- (1) Two velocity microphones are placed one with its axis directly facing in the direction of the centre of the scene, and the other with its axis at right angles to that direction. A performer speaking from the middle of the scene will affect only the face-on microphone, but if he moves to one side both microphones will provide outputs, while if he moves the other way the outputs are identical but the phase of the edge-on microphone is reversed. Since the microphones are close together no phase differences are experienced between them and if their outputs are summed and differenced after a suitable amount of relative amplification the two final channels differ in magnitude in the correct manner for operating the loud speakers to give the desired directional effect. Such sum and difference arrangement differs from the modifying network employed with pressure microphones in that the pressure type provide phase differences (whereby direction is determined) which have to be converted, whereas with the velocity type the edge-on microphone provides an output proportional to the obliquity of the source.
- (2) Two velocity microphones may be placed with their axes perpendicular to one another and each axis at 45° to the direction of the centre of the screen. They are sufficiently close together to render phase differences of the outputs negligible and the output amplitudes differ approximately proportionally to the obliquity of the incident sound. They may therefore be amplified similarly, and supplied directly to the loud speakers to which they will give the correct amplitude differences for the desired directional effect provided the relationship between the various dimensions of the recording and reproducing "lay-outs" are correct. If it is desired to accommodate any differences between the "lay-outs" the outputs may be modified by networks, in the manner described, suitably to increase or decrease the differences between them.
- (3) Two microphones may be arranged with the two axes lying symmetrically to the direction of the centre of the screen and with an angle between them of say θ degrees, so that sound from a performer at the centre subtends an angle of $\frac{\theta}{2}$ degrees to each microphone. If θ is small a small movement of the performer to one side is sufficient to make one microphone "edge-on" and to reduce its output to zero, while if θ is large a large movement of the performer is necessary to do this. By making θ adjustable different "lay-outs" may be accommodated without the modification indicated under (2) and it will be clear also that this provides a method of directional sound transmitting, recording and reproduction which avoids the necessity of combining and re-separating the two channels.
- Two velocity microphones set with their axes symmetrically inclined to the direction of the centre line of the scene, may, if placed one above the other, be employed also to provide significance of vertical as well as horizontal movement of the sound source. Such vertical displacement of the source will in this arrangement give phase differences to the outputs while lateral displacement gives amplitude differences, and these can be separated, the phase differences converted to intensity differences by modifying networks, as described, and the resulting impulses employed to operate four or more loud speakers distributed round the screen, the transmission occupying however only two channels. A similar effect may be obtained with a plurality of pressure microphones by employing suitable modification previous to transmission.
- In obtaining a complete directional "sound picture", i.e. both horizontal and vertical directional effects, the invention is not limited solely to the use of two microphones. A plurality may be employed and their outputs suitably collected and/or modified and/or separated to transmit suitable differences of impulses to a plurality of loud speakers. The general feature is that two transmitting channels, receiving impulses from two or more microphones for example, communicate two directional senses at right angles to one another, the sounds whereby this is done being provided by a plurality of loud speakers.
- It will be seen that while with pressure microphones it is preferred to transmit phase differences rather than amplitude differences and convert from one to the other in the last stage, with velocity microphones it is more convenient to transmit the two channels in phase but at different amplitudes, the only modification then necessary being an increase or decrease of the amplitude differences should the reproducing "lay-out" differ from the recording "lay-out" or should more than two loud speaker positions be used.
- There is a simple method by which modifications for increase or decrease of differences between channels may be effected if no conversion of phase differences into amplitude differences is required. The method is particularly useful for the operation of more than two loud speakers. If the transmission is effected in the form of two channels of

similar phase but different amplitudes, an alteration of these amplitude differences may be effected by connecting one wire of each channel together and connecting
 5 a choke between the other two wires of the two channels. The outgoing channels whose difference is to be a modification of the original difference, are connected to the common point of the original
 10 channels, and to tappings along the choke. If the differences are to be increased, the tappings at which the output channels are connected lie outside the tappings to which the input channels are connected,
 15 so that the choke operates in effect as an auto-transformer amplifying the difference voltages. Similarly, for a reduction of differences, the output channels are tapped intermediately between the two
 20 input channels. Modifications of this arrangement in which the devices are balanced about earth, etc. may be arranged, but the chief advantage is that the modification is varied entirely by
 25 altering tappings along a transformer or choke, and that no great power loss is involved.

This arrangement of a choke or transformer is well suited to working a number
 30 of loud speakers for binaural reproduction. In this case, the two outputs from power valves are fitted to a choke along which the loud speakers are tapped. The position of the loud speaker tappings can
 35 be adjusted to suit their relative positions, and it can be arranged that the valves are working into their best impedances. Transformers may be used to ensure the speakers taking their correct fraction of
 40 the output.

While, in connection with the above described systems, it is suggested that when it is desired to record the sounds for subsequent reproduction this may be
 45 done upon a film, the invention is not limited to that medium since the recording may if desired be effected on discs or cylinders of suitable material. In carrying out the invention in this manner the two channels may if desired be recorded
 50 in separate grooves but it is preferred that they be recorded in the same groove having a hill and dale and also a lateral cut movement. For the purposes of television previous proposals have been made
 55 whereby a wax disc has a sound record as a hill and dale cut and a picture record as a laterally cut V-shaped groove at the bottom of the hill and dale groove, or vice versa. Such records appear unsuited for
 60 separate and distinct sound recordings since undoubtedly considerable cross-talk between the two recordings would occur. They can however be used for two
 65 channels of the kind contemplated in the

present invention, one being only slightly different from the other, since a certain amount of cross-talk in this case does not matter, or can be allowed for. Further-
 70 more, the records now proposed are distinguished from those previously known in that both channels may separately be recorded in one groove by a single recording tool (either of moving iron or moving
 75 coil type) and be reproduced therefrom by a single reproducing device or pick-up.

If the two channels being recorded are directly picked up from two micro-
 80 phones, or are intended to work unmodified into two speakers, that is with intensities and qualities similar, it is preferred not to cut one track as lateral cut and the other as hill and dale, but to cut them as
 85 two tracks whose movement axes lie at 45° to the wax surface, or at some other convenient angle dependent on the relative available intensities from lateral cut and hill and dale respectively. If, how-
 90 ever, the two channels recorded are such as summation and difference channels, it is preferred to separate them completely into pure hill and dale and pure lateral cut, i.e. to make the recording axes normal and tangential to the wax surface.
 95

The result in the two above suggested cases is very similar since channels
 100 recorded at 45° to the wax surface give their sum and difference as the effective lateral and hill and dale amplitudes.

It will be appreciated that a record, cut as a combined hill and dale and lateral, may be reproduced if desired as
 105 two skew direction cuts, the basic principle being that the groove has amplitude in any direction in the plane at right angles to the direction of wax movement, and the recording and reproducing directions may be chosen as any pair of axes
 110 lines, not necessarily at right angles in this plane.

It would appear that for such a record, a material other than that now used for lateral cut records, would be desirable, and a material of the nature of cellulose
 115 acetate is indicated.

The track section is preferably adapted to work with a sapphire and have a suffi-
 120 ciently fine angle to give lateral as well as vertical control to the sapphire.

The recorder whereby both channels
 125 may be cut by a single tool on the same groove may take various forms, the underlying feature being that a light stylus is pulled in two directions at right angles to one another and each preferably at 45°
 130 to the wax surface.

In one such form the recorder may consist in a short circular reed mounted close
 135 above and parallel with the wax track.

One end of this reed may be firmly fixed in the one pole of an electromagnet which would pass back over it and complete the magnetic circuit in two laminated arms extending down towards the other free end of the reed. These arms form two poles adjacent to a square portion of the reed at its free end, each pole being adapted to pull the reed in a direction at 45° to the wax surface. The reed may be suitably damped, e.g. with rubber, and have a resonant frequency at the top of, or above, the working range. The free end of the reed carries the sapphire. The two pole pieces may be wound with speech coils, and the energisation of one of these would move the sapphire in an upward direction at 45° to the wax surface. Any reduction in the pull of one pole due to the increased flux of the other, may be compensated by additional windings on one pole connected in series with those on the other. Thus energising any winding will produce the required movement at 45° to the wax surface, the characteristic being equalised.

An alternative moving coil design employing electromagnetic damping may consist of a moving member in the shape of a T. The lower arm of the T extends towards the wax and carries the sapphire; the horizontal member of the T is at right angles to the direction of wax movement, and carries at its ends two wound moving coils. These moving coils whose axes are vertical move in suitable annular field-gaps. The movement may be supported at approximately the centre of the T by elastic means, which permit of both rotational and vertical movement within the plane of the T. Adjustments may be provided to make the resonant frequency of these two movements similar. The characteristic correction for each coil drive may be similar to those used for the moving coil sound recorder described in the specification of British Patent No. 350,998.

Energisation of one coil both rotates and translates the T member giving an inclined cutting direction. By suitably proportioning the length of the vertical member of the T this axis can be placed where desired, and further can also be controlled by interconnecting portions of the coil windings.

In all the devices described above, the angles of the axes can be altered by suitably connecting the speech windings; for instance, axes which are normally inclined at 45° to the wax surface can be converted into pure hill and dale and lateral cut axes by arranging that the speech windings are in series aiding for one channel and opposing for the other channel. In

like manner any axis conversion can be effected by suitably combining the channels through transformers.

In designing an electric pick-up to reproduce both channels care must be taken that the inertia is kept as low as possible, and with this in mind a very light replica of the above described moving iron recorder may be employed. Alternatively, a moving system in the form of a T following the lines of the moving coil recorder suggested above, may be employed; moving coils may be used for such a pick-up or the coils replaced by air gaps of an iron system. Since the fundamental resonant frequency of a pick-up appears to be of no critical importance as regards its characteristic, it may not be necessary to adjust the resonant frequency in the two modes to the same value, which would simplify the design. Adjustments for sensitivity in the two modes could be made by suitably connecting coils wound on the two limbs of the magnetic circuits.

The hereindescribed acoustic system while being especially applicable to talking pictures is not limited to such use. It may be employed in recording sound quite independently of any picture effects and in this connection (as well as when used in cinematograph work) it seems probable that the binaural effect introduced will be found to improve the acoustic properties of recording studios and to save any drastic acoustic treatment thereof while providing much more realistic and satisfactory reproduction. Furthermore, the system may clearly be employed when the microphone outputs are led directly to the loud speakers instead first of being recorded, and such an arrangement may for example be employed in public address systems in which directional sound effects are desired. In general the invention is applicable in all cases where it is desired to give directional effects to emitted sound. Also in all cases, both when the impulses are fed directly to the loud speakers and when they are recorded for subsequent reproduction the total modification and/or interaction of the channels may be accomplished in more than one stage. For example, using pressure microphones, the low frequency phase differences may be amplified, the medium frequency phase differences converted to amplitude differences, and the high frequency amplitude differences augmented in a first stage of modification; the low frequency phase differences may then be converted to amplitude differences in a later stage of modification. One or both of these stages may occur either before or after the

sound has been recorded. In this manner the very small low frequency phase differences are augmented before they are amplified, so avoiding troubles due to small low frequency phase shifts in amplifiers.

Moreover, the various devices employed for carrying the invention into effect must be understood not to be limited to their use with the other devices also herein-described since clearly many parts, such, for example, as the dual track record prepared by a single cutter, and the multi-strip direction-detecting microphone, are clearly of wide use separately of one

another. Such uses fall within the scope of this invention.

It must finally be understood that the invention is not restricted solely to the details of arrangements of the forms of the invention described above since various modifications may be introduced in order to carry the invention into effect under different conditions and requirements which have to be fulfilled without departing in any way from the scope covered thereby.

Dated this 14th day of December 1931.
MARKS & CLERK.

COMPLETE SPECIFICATION.

Improvements in and relating to Sound-transmission, Sound-recording and Sound-reproducing Systems.

We, ALAN DOWER BLUMLEIN, of 57, Earl's Court Square, London, S.W. 5, a British subject, and ELECTRIC AND MUSICAL INDUSTRIES, LIMITED, of Blyth Road, Hayes, in the County of Middlesex, a company registered under the laws of Great Britain, do hereby declare the nature of this invention and in what manner the same is to be performed, to be particularly described and ascertained in and by the following statement:—

This invention relates to the transmission, recording and reproduction of sound and is more particularly directed to systems for recording and reproducing speech, music and other sound effects. It is applicable in particular, although not exclusively, to systems associated with picture effects as in talking motion pictures.

The fundamental object of the invention is to provide a sound recording, reproducing and/or transmission system whereby there is conveyed to the listener a realistic impression that the intelligence is being communicated to him over two acoustic paths in the same manner as he experiences in listening to everyday acoustic intercourse and this object embraces also the idea of conveying to the listener a true directional impression and thus, in the case in which the sound is associated with picture effects improving the illusion that the sound is coming, and is only coming, from the artist or other sound source presented to the eye.

The invention is not, however, limited to use in connection with picture effects, but may, for example, be used for improving the qualities of public address, telephone or radio transmission systems, or for improving the quality of sound recordings. When recording music con-

siderable trouble is experienced with the unpleasant effects produced by echoes which in the normal way would not be noticed by anyone listening in the room in which the performance is taking place. An observer in the room is listening with two ears, so that echoes reach him with the directional significance which he associates with the music performed in such a room. He therefore discounts these echoes and psychologically focuses his attention on the source of sound. When the music is reproduced through a single channel the echoes arrive from the same direction as the direct sound so that confusion results. It is a subsidiary object of this invention to give directional significance to the sounds that when reproduced the echoes are perceived as such.

In order that the physical basis of the invention can be appreciated and the stages of its development understood, known and established facts concerning the physical relations between sound sources, sound waves emitted thereby, and the human ears will be briefly summarised.

Human ability to determine the direction from which sound arrives is due to binaural hearing, the brain being able to detect differences between sounds received by the two ears from the same source and thus to determine angular directions from which various sounds arrive. This function is well known and has been employed to considerable extent for example in subaqueous directional detection in which two microphones are connected by headphones, one to each ear of an observer, the two channels between the microphones and the two ears being kept entirely separate.

With two microphones correctly spaced

and the two channels kept entirely separate e.g. by using headphones it is known that this directional effect can also be obtained for example in a studio. If, however, the channels are not kept separate (as, for example is the case in previously proposed arrangements for recording and/or reproducing sound, in which sounds picked up by a plurality of pressure microphones are led to loud speakers which take the place of the headphones) the effect is almost entirely lost and such systems have therefore not come into common use since they are quite unsatisfactory for the purpose. The present invention contemplates controlling the sound, emitted for example by such loud speakers, in such a way that the directional effect will be retained.

The operation of the ears in determining the direction of a sound source is not yet fully known but it is fairly well established that the main factors having effect are phase differences and intensity differences between the sounds reaching the two ears, the influence which each of these has depending upon the frequency of the sounds emitted. For low frequency sound waves there is little or no difference in intensity at the two ears but there is a marked phase difference. For a given obliquity of sound the phase difference is approximately proportional to frequency, representing a fixed time delay between sound arriving at the two ears, by noting which the brain decides the direction from which the sound arrives. This operation holds for all frequencies up to that at which there is a phase difference of π radians or more between sounds arriving at the two ears from a source located on the line joining them; but above such a frequency if phase difference were the sole feature relied upon for directional location there would be ambiguity in the apparent position of the source. At that stage however the head begins to become effective as a baffle and causes noticeable intensity differences between the sounds reaching the two ears, and it is by noting such intensity differences that the brain determines direction of sounds at higher frequencies. It has been stated that the frequency at which the brain changes over from phase- to intensity-discrimination occurs at about 700 c.p.s. but it must be understood that this may vary within quite wide limits in different circumstances and from person to person, and that in any case the transference is not sudden or discontinuous but there is considerable overlap of the two phenomena so that over a considerable frequency range differences of both phase and intensity will to some extent have an effect

in determining the sense of direction experienced.

From the above considerations it will be clear that a directional effect is to be obtained by providing impressions at the two ears of low frequency phase differences and high frequency intensity differences, and it would appear that in reproducing from two loud speakers the differences received by two microphones suitably spaced to represent human ears would give this effect to a listener if each microphone were connected only to one loud speaker. It can be shown however that phase differences necessary at the ears for low frequency directional sensation are not produced solely by phase differences at two loud speakers (both of which communicate with both ears) but that intensity differences at the speakers are necessary to give an effect of phase difference: while initial intensity differences from the sources necessary for high frequencies are not sufficiently marked when the sounds reach the ears, and to produce suitable effects therefore the initial intensity differences must be amplified. It is for this reason that the aforementioned methods previously proposed (wherein only pressure microphones were used) are not successful in achieving the desired effect, these necessary alterations not having been understood or in any way attained in those prior arrangements.

It will be seen therefore that the invention consists broadly in so controlling the intensities of sound to be, or being, emitted by a plurality of loud speakers or similar sound sources, in suitable spaced relationship to the listener, that the listener's ears will note low frequency phase differences and high frequency intensity differences suitable for conveying to the brain a desired sense of direction of the sound origin. In other words the direction from which the sound arrives at the microphones determines the characteristics (more especially, as will become apparent hereafter, the intensities) of the sounds emitted by the loud speakers in such a way as to provide this directional sensation.

It must be understood that the manual control by an observer of intensities of a plurality of loud speakers spaced round a motion picture screen has previously been proposed but this method suffers considerably from the defects indicated above, and in any case is very difficult and inconvenient to operate. No novelty for mere intensity control per se is however claimed, except insofar as the nature of the control is such as to provide the necessary relative phase and intensity

difference sensations.

If in accordance with the invention the sound is first recorded and subsequently reproduced from the records, the control
5 may be wholly effected either during the recording or during reproduction, or may be partially carried out in each stage. It must be understood that wherever throughout this specification the words
10 "sound transmission" are employed (more especially in the claims specified below), they cover (unless the context otherwise requires) not only the case in which impulses pass directly from the
15 microphones to the loud speakers, but also those arrangements embodying an intermediate process or system of recording; and in the latter cases the said words apply to either, or both, the passage of
20 impulses from the microphones to the recording system, and from the reproducer to the loud speakers.

More specifically the invention consists in a system of sound transmission wherein
25 the sound is picked up by a plurality of microphone elements and reproduced by a plurality of loud speakers, comprising two or more directionally sensitive microphones and/or an arrangement of elements
30 in the transmission circuit or circuits whereby the relative loudness of the loud speakers is made dependent upon the direction from which the sounds arrive at the microphones.

The invention also consists in a system of sound transmission wherein the sound is received by two or more microphones, wherein at low frequencies difference in the phase of sound pressure at the microphone is reproduced as difference in
40 volume at the loud speakers.

The invention further consists in a system of sound transmission in which the original sound is detected by two or more
45 microphones of a type such as velocity microphones whose sensitivity varies with the direction of incident sound, and in which the dependence of the relative responses of the microphones to the direction of an incident sound wave is used
50 to control the relative volumes of sound emitted by two or more loud speakers.

The invention also consists in a system of sound transmission wherein impulses
55 from two microphones transmitted over individual channels are adapted to interact whereby two sets of impulses are further transmitted consisting in half the sum and half the difference respectively
60 of the original impulses, said impulses being thereafter modified to control the relative loudness of loud speakers whereby the sound is to be reproduced.

The invention also consists in a system of sound transmission wherein the sound

is picked up by two directionally sensitive microphones which are so spaced and/or with their axes of maximum sensitivity so directed relative to one another and to the sound source, that the relative loudness of loudspeakers which reproduce the impulses is controlled by the direction from which the sound reaches the microphones.

The invention also consists in a system as set forth above wherein two sets of impulses are mechanically recorded in the same groove.

The invention also consists in a system as set forth above wherein the impulses are transmitted by radio telephony.

The invention also consists in a system as set forth above in combination with means for the photographic recording or transmission and/or reproduction of
85 pictures.

The word channel, as employed herein, means an electric circuit carrying a current having a definite form depending upon the original sounds in the studio.
90 Thus two channels may be different not only because the average intensities or types of current in them differ but also because they originate from two microphones in different positions in the studio.

The nature of the invention will become apparent from the following description of various methods and modes of carrying it into effect but it must be understood that the different forms described are
95 given merely by way of example and do not impose any restrictions upon the scope of the invention or the manner and means whereby it may be accomplished.

The description will be more readily
100 understood by reference to the accompanying drawings, wherein

Figure 1 represents diagrammatically the assembly of one system according to the invention;

Figure 2 represents a microphonic arrangement for use according to one form of the invention;

Figure 3 represents a transformer arrangement employed in one form of the invention; and

Figure 4 shows a symbolic representation of the arrangement shown in Figure 3.

Figures 5, 6 and 7 represent various circuit arrangements applicable to various forms of the invention, while

Figures 8, 9, 10 and 11 represent different forms of sound recorders which may be employed.

It will be clear that the invention is particularly applicable to talking motion pictures and the following description will therefore be given with reference to this application. In one form of the in-

vention convenient for this purpose shown in Figure 1 the sounds to be recorded and reproduced with the pictures may be received from a source a by two pressure microphones a_1, a_2 mounted on opposite sides of a block of wood or baffle b which serves to provide the high frequency intensity differences at the microphones in the same way as the human head operates upon the ears as indicated above. The outputs from the two microphones are after separate amplification by separate similar amplifiers b_1, b_2 taken to suitably arrange circuits c comprising transformers or bridge or network circuits which convert the two primary channels into two secondary channels which may be called the summation and difference channels. These are arranged so that the current flowing into the summation channel will represent half the sum, or the mean, of the currents flowing in the two original channels, while the current flowing into the difference channel will represent half the difference of the currents in the original channels.

One convenient transformer arrangement for this purpose is shown in Figure 3 wherein input currents from amplifiers b_1, b_2 are separately fed each to two primary windings, one on each of two transformers, the secondary winding of each transformer providing a "sum" or "difference" output current on account of the senses in which the primary coils are wound as shown. A diagrammatic representation of a sum and difference arrangement (which may consist of a transformer similar to that of Figure 3 or any other suitable arrangement of circuit elements) is shown in Figure 4.

In accordance with the form of the invention being described the two outputs from the sum and difference arrangement are modified in order to obtain subsequently the desired sound effects and one convenient circuit arrangement for effecting this is shown in Figure 5 which represents the portion of the circuits indicated by c in Figure 1. Assuming the original currents differ in phase only, the current in the difference channel will be $\frac{\pi}{2}$ different in phase from the current in the summation channel. This difference current is passed through two resistances d and e in series between which a condenser f forms a shunt arm. The voltage across this condenser f will be in phase with that in the summation channel. By passing the current in the summation channel through a plain resistive attenuator network composed of series resistances g, h and a shunt resistance i , a voltage is obtained which remains in

phase with the voltage across the condenser f in the difference channel. These two voltages are then combined and re-separated by a sum and difference process such as previously adopted so as to produce two final channels. The voltage in the first final channel will be the sum of these voltages and the voltage in the second final channel will be the difference between these voltages. Since these voltages were in phase the two final channels will be in phase but will differ in magnitude. By choosing the value of the shunt resistance i in the summation channel and the shunt condenser f in the difference channel for a given frequency, any degree of amplitude difference in the final channels can be obtained for a given phase difference in the original channels. For the low frequencies it can be shown that the phase difference between the waves will, for a given obliquity of the sound source, vary proportionately with frequency, being very small for a very low frequency. Thus for a given obliquity of the sound the current in the difference channel will be increasingly great compared with that in the summation channel the higher the frequency. Hence the use of a shunt condenser f in the difference circuit will have the effect of producing a fixed intensity difference in the final channels for a given obliquity at all low frequencies.

For the higher frequencies as indicated above it is not necessary to convert phase shifts into amplitude differences, but simply to reproduce amplitude differences. The shunt condenser f in the difference circuit is therefore built out with a resistance k whose value is substantially equal to that of resistance i .

In building this circuit the capacity of the condenser f is of such value that its impedance is small compared with that of the series resistances d and e over the whole working range, while the value of resistance k is such that it equals the reactance of the condenser at approximately the frequency above which it is desired not to convert phase differences into amplitude differences. The value of k is in general equal to that of i , in which case the amplitude differences for high frequencies are passed on without modification.

It may be found necessary to employ more complex circuits than the shunt resistance k and condenser f in the difference circuit and shunt resistance i in the summation circuit, which however form the basic arrangement. However it must be understood that the circuits employed may be considerably modified as required without departing from the scope

of the invention.

The outputs from the modifying circuit c (Figure 1) are passed to amplifiers d_1, d_2 and thence to loud speakers e_1, e_2 suitably disposed on each side of a picture screen. It is to be understood that Figure 1 merely traces the passage of intelligence from the source a to a recipient and no recording or reproducing system has been shown. Such may however be inserted anywhere along the electrical circuit such for example as between amplifiers b_1, b_2 and modifying assembly c , or between assembly c and amplifiers d_1, d_2 .

In the latter case the impulses transmitted through the two channels as indicated above may for example be recorded on two sound tracks on a film by any suitable or known means, each of which records may comprise either a sound track of constant density and variable width (e.g. an oscillograph record), or a sound track of constant width and variable density (e.g. a light valve record). Alternatively both records may be made on a single track comprising a combination of the variable width and variable density forms of recording.

Such a record may be reproduced by passing light from the same slit through the two tracks, separating the beam into the two record portions by means of prisms or like optical means and employing the outputs from two photo-electric cells, excited by these separate parts of the beam (after amplification) to operate two loud speakers disposed one on each side of the screen upon which the cinematograph pictures are projected.

From the above description it will be clear that obliquity of the direction of sound wave propagation relative to the microphones a_1, a_2 will produce differences of intensity at the loud speakers so as to give an impression to an observer of oblique sound incidence.

If two very small microphones are used and placed very close together it may be found possible to obtain microphone outputs which do not differ appreciably in amplitude but only in phase for all working frequencies. In this case the modifying circuit may be arranged to convert phase differences into amplitude differences throughout the entire frequency range. The phase differences dealt with at the low-frequencies however may be so small that in this case slight differences in the two microphone circuits would have very large effects. On this account microphone spacing of the same order as that of the human ears is most suitable.

It will be appreciated that the amount

of modification necessary to the impulses transmitted through the summation and difference channels as indicated above depends upon a number of factors, including the relative spacing of the microphones and of the loud speakers, and the size and positioning of the screen. It can be shown that for low frequencies the degree of modification required in the difference channel as compared with the modification in the summation channel is given by:—

$$K = \frac{2v}{j\omega} \cdot \frac{y}{\theta k} \cdot \frac{s}{x}$$

where

v = velocity of sound. 80

y = fraction of half picture film width which the image of the sound source is off centre.

θ = angle of obliquity, in radians, of the source from the median plane between the microphones. 85

k = effective distance apart of the microphones.

s = width of screen of theatre.

x = distance apart of loud speakers in theatre. 90

This expression in effect gives the impedance of the shunt capacity f in the difference channel in terms of the resistance ζ in the summation channel. It holds for all frequencies where k is small compared to the wavelength, and is based on the assumption that the θ is small and that x and s are small compared with the distance of the listener from the screen and loud speakers. 95

The portion $\frac{y}{\theta k}$ is a factor of the recording, and is constant for a given arrangement if either the camera is in line with the microphones and the centre of the picture, or the action does not move appreciably to or from the microphones and camera. When recording, the relative distances of camera and microphones and the focal length of the lens may be adjusted to maintain this factor a constant. 100

The expression $\frac{s}{x}$ is a constant for the theatre. As regards low frequencies only, the distance apart of the speakers need not exceed the screen width, but should certainly not be closer than 70 per cent. of the screen width. The closer the loud speakers the greater the necessary power handling capacity, but the less the troubles introduced by formation of stationary waves. 115

For the high frequencies no definite expression can easily be obtained, and the modification, if any, used will probably 120

have to be gauged empirically by trial and error.

The arguments and formula given above are based on a direct wave analysis and may have to be considerably modified in order to allow for reflection of other acoustic effects. It is preferred therefore to introduce the modifications it is proposed to employ, at the theatre since all factors will then enter into consideration. It will be clear that, as indicated above, the modifying networks and channel arrangements may be employed between the microphones and the film during recording, or between the record and the loud speakers during reproduction, and the latter course, in addition to allowing of adjustment of the arrangements to suit the particular theatre as indicated above, has the additional advantage that the sound film can be reproduced by a single reproducing head or channel if, for example, one of the dual arrangements breaks down, or in a theatre which, having one installation, does not wish to go to the expense of installing a second apparatus.

In order to employ successfully a system of the kind described above it is necessary to carry out preliminary experiments to determine the most suitable value of modification to be employed for each recording, and it is also necessary to standardise various factors entering into every recording. In the preliminary experiments, before recording, volume indicator measurements may be made with a standard sound source placed at the extremes of the "set", i.e. the space within which recording is to be effected, and from these the proposed modifying network laid out. A further experiment may also be effected to standardise phase angles on the film. At the theatre a simple adjustment may be provided to check and balance the input to the two channels, a length of test film being used for this purpose. It will thus be seen that the total theatre equipment necessary is very simple and consists in a transmission modifier (comprising two or four transformers, for example, artificial line resistances and the control network, which may be no more than a condenser and a resistance) and two normal sound-reproducing heads or pick-ups, or one specially designed head or pick-up adapted to separate the two recordings to two complete reproducing channels. There is no reason why the second channel used should not be the "stand-by" channel now often installed for safety since if, as indicated above, one of the channels breaks down reproduction may be continued without serious consequences on the other channel only.

In connection with the standardisation indicated above, while the binaural "transfer" frequency (from phase- to intensity-discrimination) need have no definite significance in recording, since it is a function of the human brain, it is nevertheless necessary to fix a change-over frequency from high- to low-frequency working for recording, since this frequency fixes the values of the elements in the modifier and thus the form of modification to be used, the distance apart of the microphones and the form of baffle between them. Any convenient frequency may be chosen as standard after experience has decided which is most suitable. Instead of standardising it may be possible from the preliminary experiments to allow electrically for variation of microphone positions and/or of microphone spacing (although the latter would be extremely difficult) and it must be understood that this arrangement falls within the scope of the invention.

The above analysis is based upon considerations which take no account of sound reflections or interference during reproduction. The reflected sound waves which arise during recording will be reproduced with a directional sense and will sound more natural than they would with a non-directional reproducing system. If difficulties arise in reproduction they may be overcome by employing a second pair of loud speakers differently spaced and having a different modifying network from the first pair: or a row of speakers may be used with a composite, progressive modifying network to supply them: or the two speakers may be placed comparatively close together.

In this last arrangement the sense of direction of the apparent sound source will only be conveyed to a listener for the full frequency range for positions lying between the loud speakers; but if it is desired to convey the impression that the sound source has moved to a position beyond the space between the loud speakers the modifying networks may be arranged to reverse the phase of that loud speaker remote from which the source is desired to appear, and this will suffice to convey the desired impression for the low frequency sounds. With this arrangement of loud speakers close together, however, it would not be possible to effect a similar illusion in connection with high frequencies.

The system so far described employs to receive the sound waves two non-directional microphones, e.g. pressure microphones. Directionally sensitive microphones may also be employed spaced a small distance apart, the outputs being

modified as indicated so that the relative outputs of the loud speakers are controlled both by differences in phase and differences in magnitude of the microphone outputs. Such directionally sensitive microphones may be, but are not necessarily, of the type known as velocity microphones, and preferably provided with movable conductor elements so light as to move substantially as the surrounding air.

Velocity or moving conductor microphones (e.g. moving strip microphones) are very suitable for any system according to the invention and in addition to use with circuit arrangements described above: they may also be employed with various alterations in the circuits. These microphones give a response varying as the cosine of the angle of incidence of the sound relative to the direction of normal or optimum incidence, and they therefore have the advantage that a certain degree of loud speaker output separation may be obtained without phase-conversion or like network modifications.

Three general arrangements employing velocity microphones are possible, and in all cases the microphones are placed as near together as possible instead of being spaced as artificial ears, as in the case of pressure microphones.

(1) Two velocity microphones are placed one with its axis of maximum response directly facing in the direction of the centre of the scene, and the other with its axis at right angles to that direction. Both moving strips are in line, and arranged so that this line is vertical, whereas the sound source moves in a horizontal plane. A performer speaking from the middle of the scene will affect only the face-on microphone, but if he moves to one side both microphones will provide outputs, while if he moves the other way similar outputs are provided but the phase of the edge-on microphone is reversed. Since the microphones are close together no phase differences are experienced between them and if their outputs are summed and differenced after a suitable amount of relative amplification the two final channels differ in magnitude in the correct manner for operating the loud speakers to give the desired directional effect. Such sum and difference arrangement differs from the modifying network employed with pressure microphones in that the pressure type provide phase differences (whereby direction is determined) which have to be converted, whereas with the velocity type the edge-on microphone provides an output proportional to the obliquity of the source. A suitable modifying arrangement for

this form of the invention is shown in Figure 6. This is substantially identical with that shown in Figure 5 except that the shunt condenser f and resistance k in series, and the shunt resistance i are replaced by shunt resistances l m which are preferably variable as shown. These lines therefore form artificial attenuators and by altering their relative attenuation the intensity differences in the two lines corresponding to a given obliquity of sound is controlled.

(2) Two velocity microphones or microphone elements, may be placed with their axes perpendicular to one another and each axis at 45° to the direction of the centre of the screen. This arrangement is represented diagrammatically in Figure 2 wherein n and o represent two velocity, or directionally sensitive microphones one above the other arranged perpendicular to one another and at equal angles at 45° to the direction of the centre of the field from which sound is to be received. It will be clear that movement of the sound source a laterally to a position p removed from the centre of the field will result in the sound waves striking o at a more acute angle than they strike n and differences in the microphone outputs will result. The microphones are sufficiently close together to render phase differences of the incident sound negligible and the output amplitudes therefore differ approximately proportionally to the obliquity of the incident sound. They may therefore be amplified similarly, and supplied directly to the loud speakers to which they will give the correct amplitude differences for the desired directional effect provided the relationship between the various dimensions of the recording and reproducing "lay-outs" are correct. If it is desired to accommodate any differences between the "lay-outs" the outputs may be modified by networks, in the manner described, suitably to increase or decrease the differences between them. An arrangement such as shown in Figure 6 is suitable for this purpose, and such an arrangement may of course also be employed even if the lay-out is correct if it is desired for any reason to control or modify the amplitude differences of the loud speaker outputs.

(3) Two microphones may be arranged with the two axes lying symmetrically to the direction of the centre of the field and with an angle between them of say θ degrees, so that sound from a performer at the centre subtends an angle of $\frac{\theta}{2}$ degrees to each microphone. If θ is small a small movement of the performer to one side is sufficient to make one microphone

“edge-on” and to reduce its output to zero, while if θ is large a large movement of the performer is necessary to do this. By making θ adjustable different “lay-outs” may be accommodated without the modification indicated under (2) and it will be clear also that this provides a method of directional sound transmitting, recording and reproduction which avoids the necessity of combining and reseparating the two channels.

The microphone elements in any of the above cases may be enclosed in a single casing if desired for convenience, and may also be positioned in a single magnetic system common to both.

Two velocity microphones set in line with one another and with their axes of maximum response symmetrically inclined to the direction of the centre line of the scene, may, if placed one above the other, be employed also to provide significance of vertical as well as horizontal movement of the sound source in a plane perpendicular to the axis of maximum response of the microphone system. Such vertical displacement of the source will in this arrangement give phase differences to the outputs while lateral displacement gives amplitude differences, and these can be separated, the phase differences converted to intensity differences by modifying networks, as described, and the resulting impulses employed to operate four or more loud speakers distributed round the screen. The transmission in such a system occupies only two channels (one leading from each microphone) up to a point in the system where each of these channels is divided into two parallel channels thus providing four channels in all at this point. Two channels, one from each parallel pair of these divided channels, are connected to one modifying network adapted to deal with phase differences, and the other two channels, one from each pair, connected to another modifying network adapted to augment intensity differences. Each modifying network operates a plurality of loud speakers providing a directional sensation in one direction, and in this manner directional senses in two directions at right angles can be obtained. It will be seen that in such an arrangement the transmission and/or recording (which is the most expensive and difficult operation of the system) may be effected over only two channels although directional sensations in two perpendicular directions are subsequently obtained. A similar effect may be obtained with a plurality of pressure microphones by employing suitable modification previous to transmission.

In obtaining a complete directional

“sound picture”, i.e. both horizontal and vertical directional effects, the invention is not limited solely to the use of two microphones. A plurality may be employed and their outputs suitably collected, modified and separated to transmit suitable differences of impulses to a plurality of loud speakers. The general feature is that two transmitting channels, receiving impulses from two or more microphones for example, communicate impulses which can be modified and separated to provide two directional senses at right angles to one another, the sounds whereby this is done being provided by a plurality of loud speakers. It will moreover be clear that if the sound source moves away from or towards the microphones the overall intensity of the combined loud speaker propagations will vary and thus provide indication of the position of the source along that axis. Full three-dimensional location of the source is thus obtained by this arrangement.

It will be seen that while with pressure microphones it is preferred to transmit phase differences rather than amplitude differences and convert from one to the other as late as possible prior to reproduction, with velocity microphones it is more convenient to transmit the two channels in phase but at different amplitudes, the only modification then necessary being an increase or decrease of the amplitude differences should the reproducing “lay-out” differ from the recording “lay-out” or should more than two loud speaker positions be used.

There is a simple method by which modifications for increase or decrease of differences between channels may be effected if no conversion of phase differences into amplitude differences is required. The method is particularly useful for the operation of more than two loud speakers, and is also useful for working into high impedances such as the grid impedance of a thermionic valve. The arrangement is shown diagrammatically in Figure 7. If the transmission is effected in the form of two channels r & s of similar phase but different amplitudes, an alteration of these amplitude differences may be effected by connecting one wire of each channel r and s together at t and connecting a choke u between the other two wires of the two channels. The outgoing channels v and w whose difference is to be a modification of the original difference, are connected by one wire each to the common point t of the original channels, and by their other wires to tapplings along the choke u . If the differences are to be increased, the tapplings at which the output channels are

connected lie outside the tappings to which the input channels are connected, so that the choke operates in effect as an auto-transformer amplifying the difference voltages. Similarly, for a reduction of differences, the output channels are tapped intermediately between the two input channels. Modifications of this arrangement in which the devices are balanced about earth, etc. may be arranged, but the chief advantage is that the modification is varied entirely by altering tappings along a transformer or choke, and that no great power loss is involved.

This arrangement of a choke or transformer is well suited to working a number of loud speakers for binaural reproduction. In this case, the two outputs from power valves are fitted to a choke such as *u* along which the loud speakers are tapped. The position of the loud speaker tappings can be adjusted to suit their relative positions, and it can be arranged that the valves are working into their best impedances. Transformers may be used to ensure the speakers taking their correct fraction of the output.

While, in connection with the above described systems, it is suggested that when it is desired to record the sounds for subsequent reproduction this may be done upon a film, the invention is not limited to that medium since the recording may if desired be effected on discs or cylinders of suitable material. In carrying out the invention in this manner the two channels may if desired be recorded in separate grooves but it is preferred that they be recorded in the same groove having a hill and dale and also a lateral cut movement. For the purposes of television previous proposals have been made whereby a wax disc has a sound record as a hill and dale cut and a picture record as a laterally cut V-shaped groove at the bottom of the hill and dale groove, or vice versa. Such records appear unsuited for separate and distinct sound recordings since undoubtedly considerable cross-talk between the two recordings would occur. They can however be used for two channels of the kind contemplated in the present invention, one being only slightly different from the other, since a certain amount of cross-talk in this case does not matter, or can be allowed for. Furthermore, the records now proposed are distinguished from those previously known in that both channels may be recorded as separate cuts in one groove and may be recorded by a single recording tool (either of moving iron or moving coil type) and be reproduced therefrom by a single reproducing device or pick-up.

If the two channels being recorded are directly picked up from two microphones, or are intended to work unmodified into two speakers, that is with intensities and qualities similar to those of the original sounds received, it is preferred not to cut one track as lateral cut and the other as hill and dale, but to cut them as two tracks whose movement axes lie at 45° to the wax surface, or at some other convenient angle dependent on the relative available intensities from lateral cut and hill and dale respectively. If, however, the two channels recorded are such as summation and difference channels, it is preferred to separate them completely into pure hill and dale and pure lateral cut, i.e. to make the recording axes normal and tangential to the wax surface.

The result in the two above suggested cases is very similar since channels recorded at 45° to the wax surface give their sum and difference as the effective lateral and hill and dale amplitudes.

It will be appreciated that a record, cut as a combined hill and dale and lateral, may be reproduced if desired as two skew direction cuts, the basic principle being that the groove has amplitude in any direction in the plane at right angles to the direction of wax movement, and the recording and reproducing directions may be chosen as any pair of axes lines, not necessarily at right angles, in this plane.

It would appear that for such a record, a material other than that now used for lateral cut records, would be desirable, and a material of the nature of cellulose acetate is indicated.

The track section is preferably adapted to work with a sapphire and have a sufficiently fine angle to give lateral as well as vertical control to the sapphire.

The recorder whereby both channels may be cut by a single tool on the same groove may take various forms, the underlying feature being that a light stylus is pulled into two directions at right angles to one another and each preferably at 45° to the wax surface.

Figure 8 shows schematically a recorder of this kind suitable for producing records having complex cuts. 1 and 2 represent the driving elements of two recorders normally adapted for cutting lateral cut records. These driving elements drive arms 3 and 4 about axes at right angles to the plane of the paper within 1 and 2. The ends of these arms are connected by ligaments 5 and 6 to the end of a reed 7 which extends backwards along an axis perpendicular to the paper to supports not shown. This reed carries a cutting sapphire 8. Movements of the recording

arms 3 and 4 produce movements in the end of the reed 7. Thus, currents in movement 1 will cause the reed 7 to move along an axis approximately 45° to the vertical rising from left to right across the figure. Similarly, currents in movement 2 will produce movement of the reed 7 in an axis at right angles to the former axis, while currents in both movements will of course result in vertical movement of the reed.

Another such form of recorder shown in Figure 9, representing a moving iron recorder, may consist in a short reed 9 mounted close above and parallel with the wax track and carrying the cutting sapphire 8. This reed 9 may extend backwards perpendicularly to the paper to supports (not shown) which join the top of a laminated pole system 10 to complete a polarising magnetic system therewith. The two laminated arms of the pole piece 10 extend down towards the free end of the reed 9. These arms form two poles adjacent to a square portion of the reed at its free end, each pole being adapted to pull the reed in a direction at 45° to the wax surface. The reed may be suitably damped, e.g. by a rubber line, and have a resonant frequency at the top of, or above, the working range. The two pole pieces may be wound with speech coils, and the energisation of one of these moves the sapphire in an upward direction at 45° to the wax surface. The terminals 15 of one channel are connected to main winding 12 and compensating winding 11. The terminals 16 of the other channel are connected to main winding 14 and compensating winding 13. Current in either channel will pull the reed towards the pole carrying the main winding, the purpose of the compensating winding being to prevent movement of the reed away from the other pole due to the flux drawn away from this pole by the main winding. With the winding shown, currents in either channel will cause the reed to cut a track at approximately 45° to the vertical. By a suitable rearrangement of windings, or by a suitable transformer connection between the channels and the terminals of the recorder as shown, any other movement axes may be obtained. Thus for example the tool may have one movement by torsion of its supporting reed and another by flexure thereof.

An alternative moving coil design which may employ electromagnetic damping may consist of a moving member in the shape of a T as shown in Figure 10. The recorder sapphire 8 is supported on a light T member 17, which is supported at 18 by elastic means such that it may rotate about

this point, and may also translate vertically, though it is resistant to horizontal movements in the plane of the paper. The device is driven by moving coils, e.g. speech coils, 19 and 20 which are freely located and immersed in the steady magnetic field provided in annular gaps in a magnetic system, not shown. Current in one of the moving coils tends to both rotate and translate the device so that the sapphire 8 moves along an axis at approximately 45° to the vertical. The movement of this device may be damped and equalised along the lines described in British Patent Specification No. 350,998. As before any required axes of movement may be obtained by suitable interconnection of the two driving coils. Such a movement preferably has the same natural frequency for both rotation and translation. Further the distribution of mass is preferably such that a small instantaneous force applied at one coil produces no movement at the other.

Figure 11 shows another form of recorder similar in principle to the one shown in Figure 10 except that a moving iron drive is employed. The member 17 moving about axis 18 is constructed of magnetic material, or has a magnetic upper portion. The "E" shaped member 21 is polarised either by being partially permanently magnetised, or having a magnetising winding on it, so that the central pole is of opposite polarity to the two outer poles. Speech windings on the outer poles are brought out to terminals 15 and 16 to which the two channels are connected.

In all the devices described above, the angles of the axes defining the movements of the sapphire can be altered by suitably connecting the speech windings; for instance, axes which are normally inclined at 45° to the wax surface can be converted into pure hill and dale and lateral cut axes by arranging that the speech windings are in series aiding for one channel and opposing for the other channel. In like manner any axis conversion can be effected by suitably combining the channels through transformers.

In designing an electric pick-up to reproduce both channels care must be taken that the inertia is kept as low as possible, and with this in mind a very light replica of any of the above described recorders may be employed. Preferably, a moving system in the form of a T following the lines of the moving iron recorder shown in Figure 11 is employed as best suited for the purpose. Since the fundamental resonant frequency of a pick-up appears to be of no critical importance as regards its characteristic, it may not

be necessary to adjust the resonant frequency in the two modes to the same value, which would simplify the design. Adjustments for sensitivity in the two modes may be made by suitably connecting coils wound on the two limbs of the magnetic circuits. As in the recorder design the distribution of mass in the reproducer is preferably such that forces producing motion in one direction (e.g. lateral movements) leave it substantially undisturbed in its reproduction by motions in another direction (e.g. hill-and-dale).

A good binaural effect may be obtained by giving directional significance to only a limited range of frequencies. For example, although good reproduction requires the transmission of all frequencies up to, say, 10,000 c.p.s. yet a good directional effect is obtained from frequencies up to, say, 3,000 c.p.s. This would assist disc recording of the binaural impulses since the lateral cut which represents the sum of the two channels to the speakers might have a frequency range extending to 10,000 c.p.s. whereas the hill-and-dale cut need transmit frequencies no higher than 3,000 c.p.s. This would considerably simplify the design of the recorders and pick-ups in that low inertias would only be required for the lateral cut and design would thus be greatly simplified.

These frequencies are given merely by way of example, and are not necessarily the optimum frequencies for design of this character, which will be determined by other considerations.

In transmitting the two channels indicated in the various systems above described, instead of employing line transmission, radio transmission may if desired be employed. Each channel may be separately transmitted or preferably the two channels may be sent as different modulations of the same carrier wave. Thus one channel may be transmitted as an amplitude modulation and the other as a phase or frequency modulation of the same carrier wave.

Alternatively the two channels may be transmitted as amplitude modulations of different carrier waves which are 90° out of phase, the two waves being radiated from the same aerial in combination as a single wave propagation. Various systems for the transmission and reception of duplex radio signals along these lines are known and any one of such or similar arrangements may be used in connection with the invention described herein according to its applicability or convenience in the circumstances under consideration. It must be understood that with such a system of duplex radiation, it is possible, if desired, to perform one of

the summing and differencing processes in the radio link. For example, by demodulation at the receiving end with two carrier waves 90° out of phase, which carrier waves are 45° out of phase with the original modulating carriers, the resultant low frequency channels are the sums and differences of the original low frequency channels at the transmitter.

The hereindescribed system while being especially applicable to talking pictures is not limited to such use. It may be employed in recording sound quite independently of any picture effects and in this connection (as well as when used in cinematograph work) it seems probable that the binaural effect introduced will be found to improve the acoustic properties of recording studios and to save any drastic acoustic treatment thereof while providing much more realistic and satisfactory records for reproduction. Furthermore, the system may clearly be employed when the microphone outputs are led to the loud speakers instead first of being recorded, and such an arrangement may for example be employed in public address systems in which directional sound effects are desired. In general the invention is applicable in all cases where it is desired to give directional effects to emitted sound. Also in all cases, both when the impulses are fed to the loud speakers without recording and when they are recorded for subsequent reproduction the total modification and/or interaction of the channels may be accomplished in more than one stage. For example, using pressure microphones, the low frequency phase differences may be augmented, the medium frequency phase differences converted to amplitude differences, and the high frequency amplitude differences augmented in a first stage of modification; the low frequency phase differences may then be converted to amplitude differences in a later stage of modification. One or both of these stages may occur either before or after the sound has been recorded. In this manner the very small low frequency phase differences are augmented before they are amplified, so avoiding troubles due to small low frequency phase shifts in amplifiers.

Moreover, the various devices employed for carrying the invention into effect must be understood not to be limited to their use with the other devices in the systems also hereindescribed since clearly many parts, such, for example, as the dual track record prepared by a single cutter, and the multi-strip direction-detecting microphone, are clearly of wide use in such systems separately from one another. Such uses in binaural systems

as herein described fall within the scope of this invention.

It must finally be understood that the invention is not restricted solely to the details of arrangements of the forms of the invention described above since various modifications may be introduced in order to carry the invention into effect under different conditions and requirements which have to be fulfilled without departing in any way from the scope covered thereby.

Having now particularly described and ascertained the nature of our said invention and in what manner the same is to be performed, we declare that what we claim is:—

1. A system of sound transmission wherein the sound is picked up by a plurality of microphone elements and reproduced by a plurality of loud speakers, comprising two or more directionally sensitive microphones and/or an arrangement of elements in the transmission circuit or circuits whereby the relative loudness of the loudspeakers is made dependent upon the direction from which the sounds arrive at the microphones.

2. A system of sound transmission wherein the sound is received by two or more microphones, wherein at low frequencies difference in the phase of sound pressure at the microphones is reproduced as difference in volume at the loud speakers.

3. A system of sound transmission, in which the original sound is detected by two or more microphones of a type such as velocity microphones whose sensitivity varies with the direction of incident sound, and in which the dependence of the relative responses of the microphones on the direction of an incident sound wave is used to control the relative volumes of sound emitted by two or more loud speakers.

4. A system of sound transmission wherein two or more microphones are used to detect the original sound, and both the relative phase and volume of the output of the two microphones are used to control, according to the direction of incidence of the original sound wave, the relative output volumes of two or more loud speakers.

5. A system according to any of Claims 1—4 in which two or more channels are combined and separated into other channels so that the resultant channels, though not similar to the former channels, are modifications of them conveying the same directional intelligence in another form.

6. A system of sound transmission, wherein impulses from two microphones

transmitted over individual channels are adapted to interact whereby two sets of impulses are further transmitted consisting in half the sum and half the difference respectively of the original impulses, said impulses being thereafter modified to control the relative loudness of loud speakers whereby the sound is to be reproduced.

7. A system as claimed in Claim 6 wherein after modification the two sets of impulses are treated by a repetition of the sum and difference process initially effected.

8. A system as claimed in Claim 6 or 7 wherein after the initial impulses have been translated to sum and difference impulses modification is effected in each sum and difference channel by attenuator networks and/or phase modifying arrangements.

9. A system as claimed in Claim 8 wherein modification of the impulses is effected by plain shunt elements, e.g. resistances and/or condensers, which may be variable in value.

10. A system according to any of Claims 5—9 wherein for part of the frequency range phase differences in the original channels are converted to amplitude differences in the resultant channels.

11. A system according to any of Claims 5—10 wherein over all or part of the frequency range the differences between the channels are augmented or reduced.

12. A system according to any preceding claim comprising two separate microphones arranged apart by a short distance, approximately equal, for example, to the separation of the human ears.

13. A system according to Claim 12 comprising two pressure microphones between which a baffle is provided.

14. A system according to any of Claims 2 or 4—12 comprising directionally sensitive microphones.

15. A system of sound transmission wherein the sound is picked up by two directionally sensitive microphones which are so spaced and/or with their axes of maximum sensitivity so directed relative to one another and to the sound source, that the relative loudness of loud speakers which reproduce the impulses is controlled by the direction from which the sound reaches the microphones.

16. A system as claimed in any of Claims 1—11, 14 or 15 comprising two velocity microphones or microphone elements placed in close juxtaposition with their axes of maximum sensitivity pointing in different directions.

17. A system as claimed in any of Claims 1—12 or 14—16 comprising

- velocity microphones or microphone elements in the form of a conductor so light as to move substantially as the surrounding air.
- 5 18. A system as claimed in any of Claims 1—12 or 14—17 wherein a plurality, e.g. two, velocity microphone elements are built into a single container with a common magnetic system, or
10 separate magnetic systems.
19. A system as claimed in any of Claims 1—12 or 14—18 comprising two velocity microphones, one with its element perpendicular to the direction of the
15 centre of the "sound field" and the other with its element in line with said direction, both elements lying longitudinally in line, and at right angles to the plane in which the sound source moves.
- 20 20. A system as claimed in any of Claims 1—12 or 14—18 wherein two velocity microphones lie with their elements at equal angles (e.g. each at 45°) to the direction of the centre of the sound
25 field.
21. A system as claimed in any of Claims 1—12, 14—18 or 20 comprising two velocity microphone elements the angle between which (and hence the angle
30 of each relative to the centre of the "sound field") is adjustable.
22. A system as claimed in any of Claims 15—21 wherein the directionally sensitive microphones are so arranged and
35 directed as to provide impulses whereby the desired relative loudnesses of the loud speakers are obtained, said impulses being transmitted to the loud speakers without modification or interaction.
- 40 23. A system as claimed in any of Claims 15—21 wherein the impulses generated by the directionally sensitive microphones are modified (e.g. by attenuator networks in sum and difference channels)
45 before being reproduced by the loud speakers.
24. A system as claimed in Claim 23 wherein modification is effected by a common choke inserted between two
50 microphones and two loud speakers, four leads (one from each microphone and each loud speaker) being connected together while the other lead from each member is movably connected to tapplings on the
55 choke.
25. A system as claimed in any of Claims 1—21, 23 or 24 wherein the modification of the impulses is effected in two or more stages.
- 60 26. A system as claimed in any preceding claim wherein the transmitted impulses are photographically recorded upon separate film sound tracks, preferably adjacent to one another, either track being
65 either of the variable width, or variable density form.
27. A system as claimed in any of Claims 1—25 wherein a record of two sets of impulses is located upon a single film track in the form of a combined variable
70 width and variable density recording.
28. A system as claimed in any of Claims 1—25 wherein the impulses are recorded upon discs or cylinders of wax or like suitable material.
75
29. A system as claimed in any of Claims 1—25 or 28 wherein the two sets of impulses are recorded upon the same cylinder or disc.
30. A system as claimed in Claim 29
80 wherein two sets of impulses are mechanically recorded in the same groove.
31. A system as claimed in Claim 29 or 30 wherein one record is a lateral cut and the other a hill-and-dale cut in a
85 single groove.
32. A system as claimed in any of Claims 28—31 wherein the recordings are effected simultaneously.
33. A system as claimed in any of Claims 28—32 wherein the recordings are effected by a single cutting tool.
90
34. A system as claimed in Claim 33 wherein the cutting tool is capable of controlled movement in all directions in a plane perpendicular to the direction of
95 movement of the wax.
35. A system as claimed in Claim 33 or 34 wherein the cut of the recording tool is in form a combination of lateral
100 and hill-and-dale cuts, or equivalent to that form.
36. A system as claimed in any of Claims 28—35, wherein one channel is recorded as a cut in a direction at an
105 angle to the normal to the wax and the other channel is recorded as a cut at the same angle to the normal to the wax but on the other hand relative to the groove.
37. A system as claimed in any of Claims 26—36, wherein the desired modification of the two channels is wholly effected either before recording or after reproduction from the record, or is partially effected in each stage.
110
38. A sound reproducing system wherein the sounds are reproduced without modification from one or more sound records prepared by a system according to any preceding claim.
115
39. Microphone arrangements for a system according to any preceding claim comprising a plurality of directionally sensitive elements arranged with a common magnetic system, or separate
125 magnetic systems, in a common casing or container, the axes of maximum sensitivity of the elements being arranged at an angle to one another, the elements being connected to separate transmission
130

channels whereby the impulses are separately transmitted from the elements.

40. Microphone arrangements as claimed in Claim 39, wherein the angle between the elements is adjustable.

41. A system according to any of Claims 28—37, embodying a sound recorder comprising an operating movement adapted to respond to both channels of impulses and to cut records of both simultaneously.

42. A system embodying a sound recorder as claimed in Claim 41 comprising a single cutting tool adapted to operate in a single groove.

43. A system embodying a sound recorder as claimed in Claim 41 or 42 adapted to effect a different kind of recording cut (e.g. lateral or hill-and-dale) for each of the channels.

44. A system embodying a sound recorder as claimed in Claim 41 or 42 adapted to respond in similar manner to, and effect cuts of similar form for, each channel, but in opposite sense relative to the groove.

45. A system embodying a sound recorder as claimed in any of Claims 41—44 comprising a cutting tool capable of controlled movement in all directions in a plane perpendicular to the direction of movement of the wax.

46. A system embodying a sound recorder as claimed in any of Claims 41—45 comprising a cutting tool the movements of which in two directions, perpendicular or at an angle to one another, are separately controlled by the driving arms of separate recording elements.

47. A system embodying a sound recorder as claimed in any of Claims 41—45 comprising a cutting tool carried upon a flexible reed adapted to be moved in either of two directions, perpendicular or at an angle to one another; or to be subjected to a resultant movement equivalent to the combination of such motions in both directions.

48. A system embodying a sound recorder as claimed in Claim 47 wherein movements of the reed are effected by electromagnetic forces imposed by adjacent poles of a co-operating magnetic system excited by the impulses to be recorded.

49. A system embodying a sound recorder as claimed in Claim 48 wherein compensating coils are wound on the magnetic system in addition to the exciting speech coils in order to neutralise effects upon one pole of impulses in the speech coil of the other pole.

50. A system embodying a sound recorder as claimed in any of Claims 41—45 comprising a cutting tool assembly

adapted to have one movement by torsion of its supporting reed and another by flexure thereof.

51. A system embodying a sound recorder as claimed in Claim 50 wherein the cutting tool assembly is driven by moving coil drives, comprising speech coils attached thereto freely immersed in a steady magnetic field.

52. A reproducer for a transmitting system as claimed in any of Claims 1—38, comprising elements of small weight and inertia but otherwise substantially identical in form and arrangement with those of a recorder as claimed in any of Claims 41—51, the cutting tool therein being replaced by a stylus whereby electrical vibrations are produced in the magnetic windings by vibrations imparted to the movable reed or like movable armature.

53. A system as claimed in Claim 41 embodying a sound recording or sound reproducing device substantially as represented in Figure 9.

54. A system as claimed in Claim 41 embodying a sound recording or sound reproducing device substantially as represented in Figure 10.

55. A system as claimed in Claim 41 embodying a sound recording or sound reproducing device substantially as represented in Figure 11.

56. A sound record prepared by a system as claimed in any of Claims 1—38 or 41—51.

57. A sound record comprising in one groove two substantially separate records of sound which emanate from the same source, which sounds are picked up by directionally sensitive devices and/or are subjected to modifications by elements in the recording circuit, in such a manner that when the records are reproduced, one in one loud speaker and the other in another loud speaker, the intensities of the sounds simultaneously propagated convey in combination a true binaural effect to the listener.

58. A sound record as claimed in Claim 57 comprising separate cuts of different form, or of same forms along any pair of axes in a plane perpendicular to the direction of movement of the wax, for the separate recordings.

59. A sound reproducing device adapted to reproduce sounds from motions in one direction (e.g. lateral movements) on a sound record prepared according to any of Claims 43—51, while remaining substantially undisturbed in its reproduction by motions in another direction (e.g. hill-and-dale).

60. A system as claimed in any of Claims 1—39 wherein the impulses are

70

75

80

85

90

95

100

105

110

115

120

125

130

transmitted by radio telephony.

61. A system as claimed in Claim 60 wherein transmission is effected by the duplex modulation of a single carrier wave, or by radiation of a single wave formed of separately modulated components.

62. A system as claimed in any of Claims 1—39, 60 or 61 in combination with means for the photographic recording, or for the reproduction of pictures.

63. A sound and picture reproducing system as claimed in Claim 62 wherein the relative volumes of the reproducing loud speakers are so controlled as to provide apparent location of the sound origin in coincidence with the optical location of the image from which the sound is supposed to emanate.

64. A system as claimed in Claim 62 or 63 wherein the relative modifications of the two channels is determined by the dimensions and lay-out of scene to be recorded, and/or the theatre in which reproduction is presented.

65. A system as claimed in Claim 62, 63 or 64 wherein the relative values of the modifying networks in the two channels is defined by the formula

$$K = \frac{2v}{j\omega} \cdot \frac{y}{\theta k} \cdot \frac{s}{x}$$

where the symbols have the meanings defined herein.

66. A system as claimed in any of Claims 1—39 or 60—65, or a plurality of such systems in combination as a single system, adapted to provide a full directional significance to sounds emitted by a source movable in any direction in a plane-perpendicular to the axis of maximum response of the microphone system.

67. A system as claimed in Claim 66 wherein the total sound emission of all loud speakers determines the position of the sound source along the said axis of maximum response, so that full three-dimensional acoustic location of the sound source is obtained.

68. Systems of sound transmission substantially as described herein, with reference to the accompanying drawings.

69. Means for the transmission, recording and reproducing of sound substantially as described herein with reference to the accompanying drawings.

70. Systems for the transmission, recording and reproduction of combined picture and sound effects substantially as described herein with reference to the accompanying drawings.

Dated this 9th day of November, 1932.
MARKS & CLERK.

[This Drawing is a reproduction of the Original on a reduced scale.]

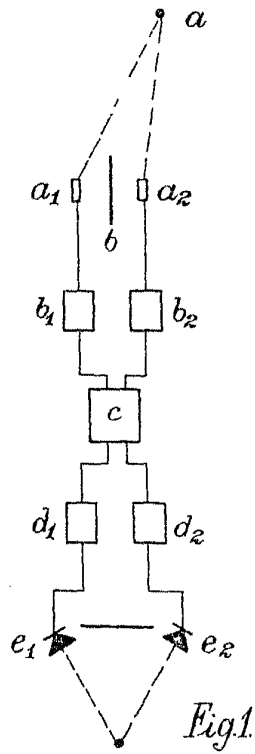

Fig. 1.

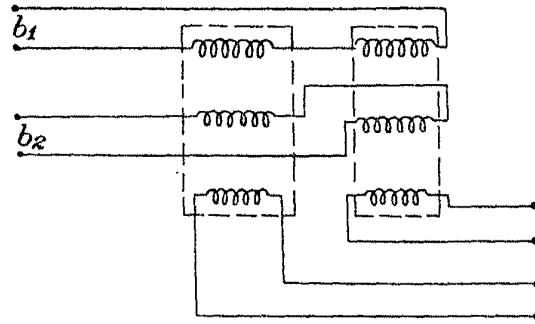

Fig. 3.

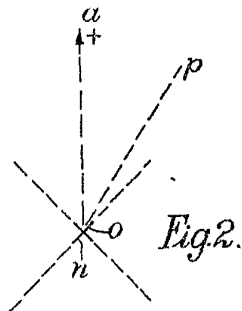

Fig. 2.



Fig. 4.

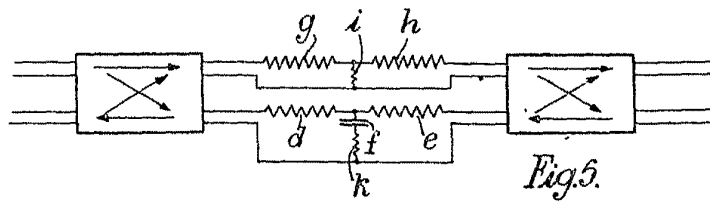

Fig. 5.

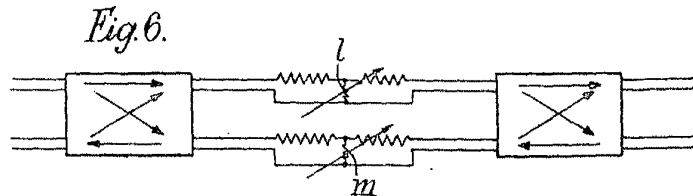

Fig. 6.

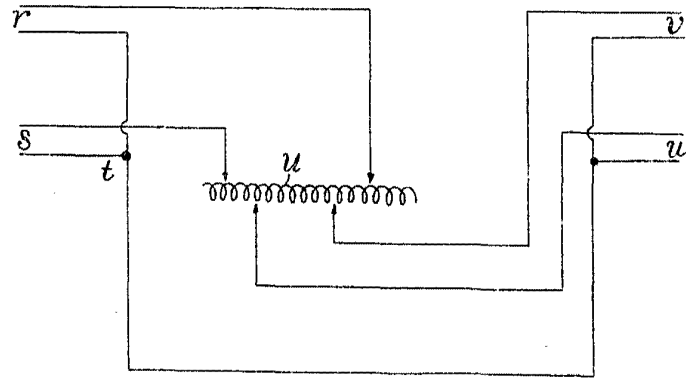

Fig. 7.

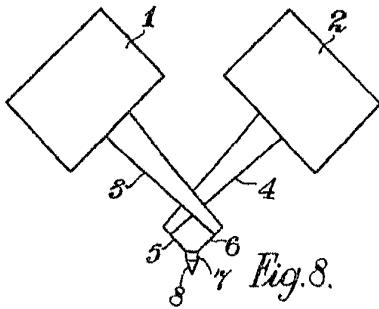

Fig. 8.

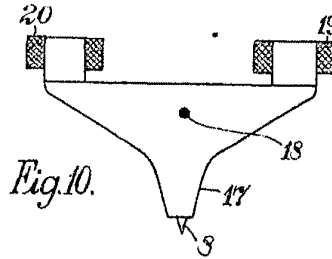

Fig. 10.

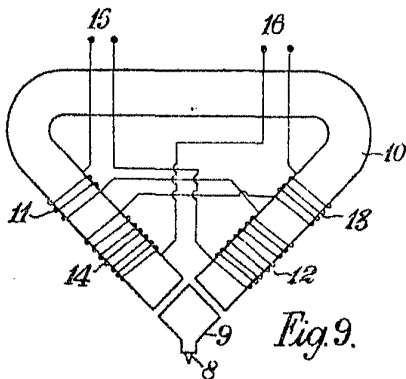

Fig. 9.

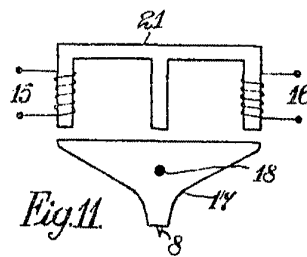

Fig. 11.